

Microwave Oven Interference on Wireless LANs Operating in the 2.4 GHz ISM Band

Ad Kamerman
Lucent Technologies - WCND
Zadelstede 1-10, 3431 JZ Nieuwegein
The Netherlands
Tel: (+31) 30 60 97 479
Fax: (+31) 30 60 97 556
E-mail: kamerman@lucent.com

Nedim Erkoçevic
Lucent Technologies - WCND
Zadelstede 1-10, 3431 JZ Nieuwegein
The Netherlands
Tel: (+31) 30 60 97 438
Fax: (+31) 30 60 97 556
E-mail: erkocevic@lucent.com

Abstract - Commercial microwave ovens as applied in restaurants have two magnetron tubes and compared to domestic kitchen counterparts they spread the higher RF power and radiated heating energy more evenly. The domestic kitchen or residential microwave ovens have only one magnetron tube. The interference from the commercial type of microwave ovens is more difficult to characterise than the interference from the residential ones. The commercial type of microwave ovens radiate a CW-like interference that sweeps over tens of MHz during the two bursts per mains power cycle. The residential ones give a CW-like interference that has a more or less stable frequency near 2.45 GHz occurring once per mains power cycle. The impact of the interference from the commercial type of microwave ovens on wireless LANs conforming the IEEE 802.11 standard for both DSSS (direct sequence spread spectrum) and FHSS (frequency hopping spread spectrum) has been evaluated.

I. INTRODUCTION

The release of the 2.4 GHz unlicensed band (2400 - 2483.5 MHz) for ISM (industrial, scientific, medical applications) prompted a significant interest in the design of wireless LAN products. Interference from extraneous sources (unintentional radiators) impacts the reliability of communication in this 2.4 GHz ISM band. Sources of such interference are the millions of residential microwave ovens radiating at frequencies close to 2.45 GHz, and they have been described largely in the literature. Commercial microwave ovens, based on two magnetron tubes as used in restaurants, have been hardly described in the literature. Since commercial ovens are expected more often in the vicinity of office buildings with a high population density of office equipment and PCs, this type has been evaluated with respect to the nature of the interference signal and the impact on wireless LANs operating in the 2.4 GHz ISM band.

At first, published material on residential microwave ovens, the reports from the NTIA (National Telecommunications and Information Administration, in the US) - [1] and [2] - are discussed. Next, the commercial microwave ovens and the nature of their interference is considered. The characterization of the interference from such ovens requires a dedicated measurement set up. Then the robustness of wireless LANs based on DSSS and FHSS conformant to IEEE 802.11 against CW interference is discussed. At last, the interference from the commercial microwave ovens on wireless LANs based on DSSS and FHSS is measured with a dedicated set up and the impact of the interference nature is considered.

II. NTIA REPORTS

The NTIA makes [1] and [2] some pessimistic conclusions about the possibility of sustaining highly-reliable communication links in this band. The ubiquitousness of these ovens and the wideband interference picture that emerges from peak-power measurements using, for example, conventional spectrum analysers in max-hold mode and multiple sweeps, has led to these pessimistic conclusions. The NTIA describes measurement results for residential microwave ovens with a maximum EIRP for these radiators that lies lay between +16 and +33 dBm.

Some shortcomings in the NTIA measurement methods are presented in [3]. The NTIA reports give results of frequency- and time-domain measurements. Spectrum analysers in max-hold mode were used to measure in the frequency domain, which resulted in traces that capture the peak emission, at each frequency sampling point, occurring during the time interval of observation. Spectrum analysers in zero-span trace mode were used to find how the signal power around the selected frequency varies over time. [3] mentions that the NTIA peak spectrum measurements and frequency-domain characterisation with time-domain plots show a pulsed

nature, although a time-frequency characteristic is not shown in the NTIA evaluation. A real-time digital spectrum analyser can be used to overcome this shortcoming in the NTIA measurement approach.

III. RESIDENTIAL MICROWAVE OVENS

Microwave ovens have become more popular over the last fifteen years and can be found in over two hundred million home kitchens. The heating source of these residential microwave ovens is based on a single magnetron tube mostly positioned in an upper corner. Without further provisions, such an oven would produce an uneven heating effect, because of static stable standing wave patterns inside the cavity of the oven. Therefore, the usage of a rotating disk results in such a heating process at which the different sides of the rotated food or drink are “illuminated” more evenly. The power consumption is mostly in the 600 - 800 Watt range.

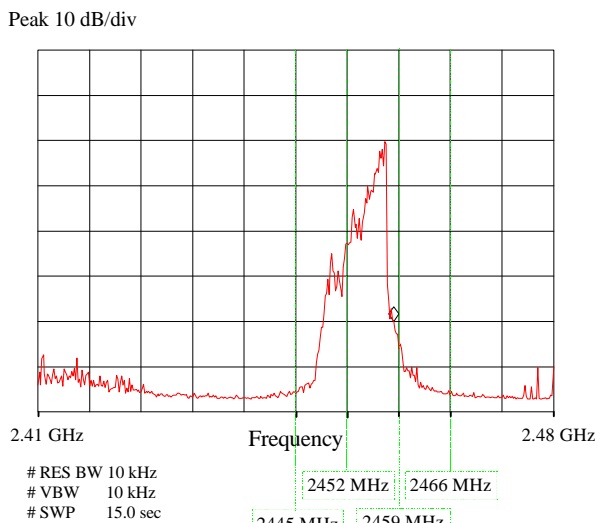

Fig. 1. Max-hold spectrum for residential microwave oven.

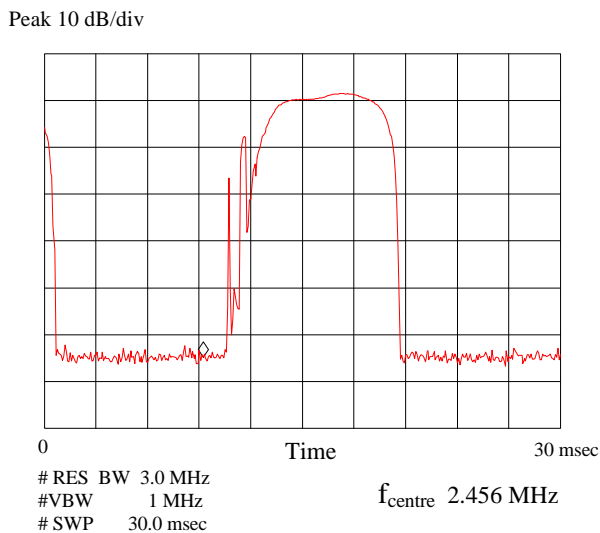

Fig. 2. Zero-span spectrum for residential microwave oven.

Figs. 1 and 2 give respectively the max-hold spectrum and active time (zero-span spectrum) of a typical residential oven. These figures are obtained with the oven loaded with a mug of 2 dl water. They are in line with the

NTIA measurement approach. With a high speed digital oscilloscope it can be shown, that during the active period the emitted signal is a CW with a frequency that moves over a few MHz. The beginning of the burst looks like a pulsed CW of which the frequency can vary more, and the radiated signal strength is lower. The end of the burst looks like the pulsed beginning and also has a lower level. Although there are many differences between the emissions from ovens of different manufacturers, the centre burst frequency is mostly somewhere around 2450 - 2460 MHz, and the sweep goes over 2 - 6 MHz. Likewise, the total active period is about 8 msec (out of the 20 msec mains power cycle at 50 Hz, or 16 msec at 60 Hz) of which the first and last 1 msec of the burst considered the beginning and end, have a pulse nature.

IV. COMMERCIAL MICROWAVE OVENS

Microwave ovens which are used for commercial applications, are based on two magnetron tubes which are alternately active during one half of the mains power cycle of 20 msec. As illustrated in Fig. 3, the radiated electro-magnetic waves from the $\lambda/2$ waveguides that are mounted on the two magnetron tubes are reflected by the rotating disk with metal mirror plates. This type of oven has a power consumption in the 1200 - 2500 Watt range and the cabinet is a more solid one of stainless steel.

In an attempt to measure the max-hold spectrum for a commercial microwave oven, we found a characteristic as shown in Fig. 4, which occupies a much wider spectrum than the one found for a residential oven as illustrated in Fig. 1. To characterise signals from a commercial oven we used an approach based on down mixing with a 2450 MHz carrier and filtering with a steep low-pass filter¹ to provide a baseband signal that is offered to a digital oscilloscope (a 125 MHz dual digital oscilloscope).

In order to capture the oven activity over a full mains power cycle, we have selected a lower sampling resolution for the digital oscilloscope. Fig. 5, which is obtained in this way, illustrates the variation in the envelope of the CW-like microwave oven signal.

A pulsed behaviour similar to the one found for a residential oven, is observed during the beginning and the end of the burst. The commercial oven shows a random variation in frequency over tens of MHz, meaning that it covers a considerably wider frequency band than the domestic brother. The commercial oven gives a large power variation, as illustrated in Fig. 5.

V. WIRELESS LANs BASED ON DSSS AND FHSS

Currently available wireless LAN products employ either DSSS (direct sequence spread spectrum) or FHSS (frequency hopping spread spectrum) modulation techniques. Both are viable choices of spread spectrum techniques and have field-proven usage in the 2.4 GHz

¹ 7th order Chebychev, -3 dB @ 37.5 MHz, -60 dB @ 76 MHz

unlicensed band for ISM (industrial, scientific, medical) applications. However, DSSS and FHSS techniques have different behaviour and thus fit differently in specific applications and environments.

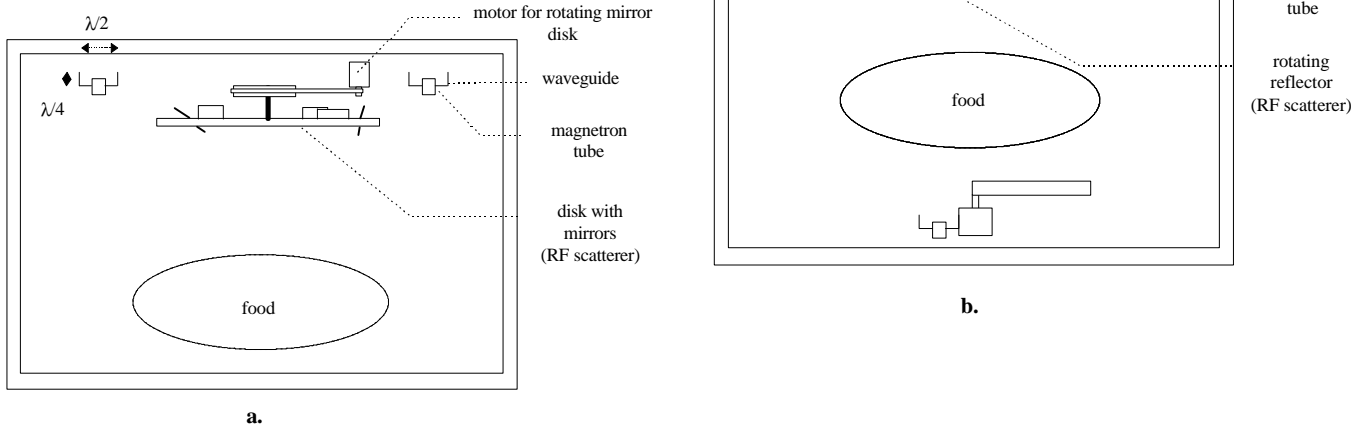
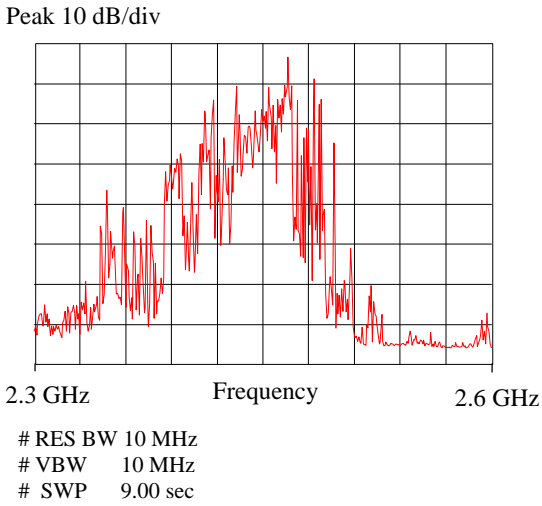
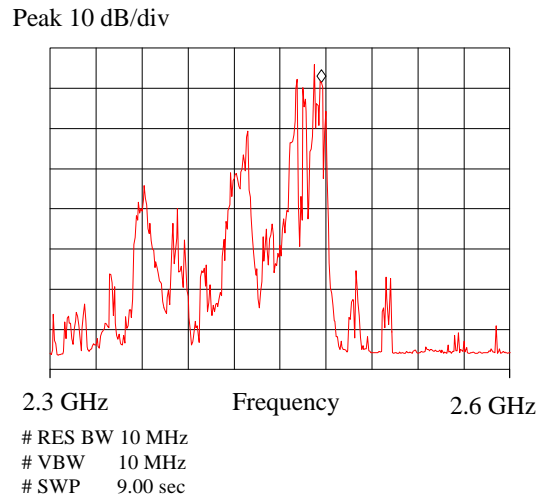

Fig. 3. Commercial microwave oven with two magnetron tubes.
 a. model A with rotating mirror plates, b. model B with reflector in bottom and ceiling.



a.



b.

Fig. 4. Max-hold spectrum for commercial microwave oven.
 a. model A, b. model B.

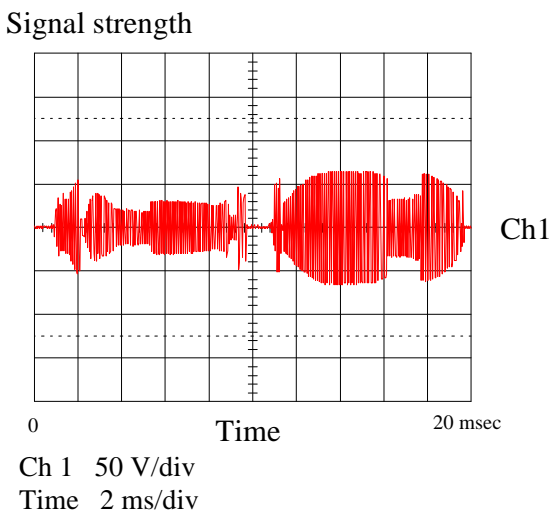
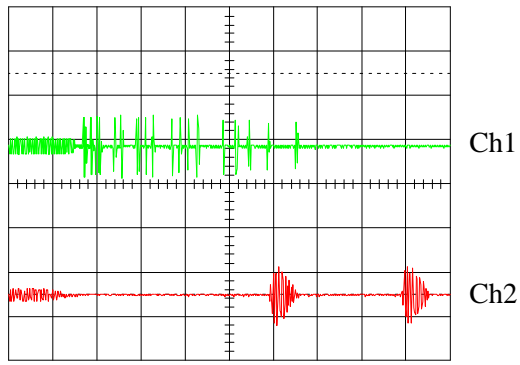

Fig. 5. Envelope/duty cycle of band-filtered signal from commercial microwave oven.

Signal strength



Ch 1 /Ch 2 50 mV/div
Time Ch 1 20 μ sec/div
Time Ch 2 1 μ sec/div

Time

Fig. 6. Some details of an end-burst from a commercial microwave oven.

The IEEE 802.11 standard for wireless LANs [4] defines the MAC (medium access control) and PHY (physical layer) protocols for access point based networks and ad-hoc networks. IEEE 802.11 supports DSSS with differentially encoded BPSK and QPSK, FHSS with GFSK (Gaussian FSK), and infrared with PPM (pulse position modulation). With DSSS and infrared the basic bit rates are both 1 and 2 Mbit/s. With FHSS the basic bit rate is 1 Mbit/s, while 2 Mbit/s is optional. The basic medium access behaviour allows interoperability between compatible PHYs through the use of CSMA/CA (carrier sense multiple access with collision avoidance) and a random backoff time following a busy medium condition. In addition, all directed traffic uses immediate positive acknowledgement (ACK frame), whereby the sender schedules a retransmission if no ACK is received.

For wireless LAN applications we have to consider Ethernet-like packet traffic. Although 802.11 specifies a maximum packet size of 2304 bytes, the currently installed base of network operating systems will seldom allow packet sizes that are larger than 1500 bytes, which applies for an Ethernet protocol stack. Therefore, the packet size will mostly vary in the range from 64 bytes up to 1500 bytes. Short packets contain control information and long packets contain information as during file transfer. Then the transmission of the 802.11 PHY frames (including the PHY preamble/header and the MAC field) take for both DSSS and FHSS from 0.9 msec up to 12.4 msec for 1 Mbit/s and from 0.6 msec up to 6.3 msec for 2 Mbit/s. With DSSS, a selected channel frequency is used continuously, while with FHSS the frequency is hopped from hop channel to hop channel at regular intervals. The channel hopping conforms to of many possible predefined hopping patterns. The default dwell time (time to stay at a hop channel frequency) for 802.11 FHSS is 20 msec.

VI. WIRELESS LANs AND CW INTERFERENCE

DSSS and FHSS systems differ in sensitivity for CW interference. The required SIR with respect to in-band interference for reliable operation depends on the type of modulation. For the 802.11 DSSS with BPSK and QPSK we assume coherent detection. The 802.11 FHSS defines unusually low values for the modulation index h ($h=0.34$ @ 1 Mbit/s, $h=0.15$ @ 2 Mbit/s) to allow more hop frequencies. Because of this low modulation index for 802.11 FHSS, a significantly higher SIR is required than at the common modulation index $h=0.5$. [5] gives the difference in SNR requirements between 802.11 DSSS/BPSK (1 Mbit/s), -/QPSK (2 Mbit/s) and 802.11 FHSS/GFSK-2 (1 Mbit/s), -/GFSK-4 (2 Mbit/s). Observing these differences in SNR performance, FHSS needs extra margins in terms of required SIR. Compared to DSSS/BPSK @ 1 Mbit/s, DSSS/QPSK @ 2 Mbit/s needs 3 dB extra SIR. While FHSS/GFSK-2 @ 1 Mbit/s needs 7 dB extra SIR and FHSS/GFSK-4 @ 2 Mbit/s needs 13 dB extra SIR.

However, we have to keep in mind that in-band CW interference affects a DSSS system differently than a FHSS system, since the receiver bandwidth for DSSS is much larger. Thus, against the larger probability of an in-band interferer there is the advantage of processing gain that means suppression of the in-band CW signal relative to the DSSS signal. Due to this effect of processing gain, the estimated required SIR with respect to in-band CW interference is for DSSS @ 1 Mbit/s -4 dB and for DSSS @ 2 Mbit/s -1 dB (meaning that the received CW interference can be even stronger than the received signal). With FHSS, the in-band frequency range is much smaller, but the vulnerability to in-band CW interference is much larger. Due to the effect of the low modulation index, the estimated required SIR for in-band CW interference is for FHSS @ 1 Mbit/s 13 dB and for FHSS @ 2 Mbit/s 16 dB.

Overall the philosophy behind DSSS is “live in presence of CW interferers”, while FHSS live by the rules “try to jump around the CW interferers” - otherwise drop dead.

VII. WIRELESS LANs AND MICROWAVE OVEN INTERFERENCE

Section III has discussed the interference from residential microwave ovens, which give more or less repetitive CW bursts with a limited frequency variation. As long as the wireless LAN device does not receive interference at a level that blocks the linearity of its input stage, the receiver operates well as long as it meets the required in-band SIR. With DSSS, the resistance against an in-band interference is 17 dB better, but with FHSS the risk is associated with in-band interference is about ten times lower. However, since the residential oven interference is present during 8 msec of a 20 msec power cycle interval, the recovery scheme of the MAC protocol will significantly reduce the effect of strong in-band interference. While DSSS can select clean channels (lower part of the 2.4 GHz band), FHSS has no control over avoiding certain hop channels because it simply has to hop over all² channels independent of how clean these channels are.

Section IV has discussed the interference from commercial microwave ovens, which give a more or less unpredictable chirp signal with a much wider frequency variation.

To characterise the robustness of wireless LANs (both DSSS and FHSS) against a commercial microwave oven that gives a fast sweeping CW, we measured the down-mixed signal behind two low-pass filters. One low-pass filter corresponds to a 802.11 FHSS receive filter characteristic³. and another (much wider) low-pass filter corresponds to a 802.11 DSSS receive filter

² In US and Europe 79 hop frequencies.

³ A 5th order low-pass Chebychev filter with 5.4 dB @ 450 kHz and 36 dB @ 900 kHz.

characteristic⁴. In practical systems, the receive band selectivity filtering is likely done at an IF stage with a SAW filter.

Section V has discussed the packet transmission times (for both DSSS and FHSS) and hop intervals (for FHSS). Before looking at Figs. 7 and 8, we have to be aware that typical packet transmission times go up to 6 msec (@ 2 Mbit/s) and 12 msec (@ 1 Mbit/s). Furthermore, for FHSS, we have to consider staying at the same hop channel frequency during say 20 msec intervals. In Figs. 7a and 8a, the typical transmission time ranges are indicated.

Figs. 7a-e and 8a-f show the envelope of the interference from commercial microwave ovens for model A and model B respectively, after down-mixing and low-pass filtering with characteristics described above for 802.11 FHSS and DSSS. The upper trace represents in-band interference at 802.11 FHSS using a fixed channel frequency (during the same hop interval) at 2400 + XX MHz. The lower trace represents in-band interference at 802.11 DSSS using a channel centred at 2400 + XX MHz. These upper and lower traces are made with a dual digital oscilloscope, but the magnitude of the upper one has been multiplied by a factor of 10 (20 dB) to compensate for a different CW interference vulnerability⁵ of the compared systems. The dual trace of Fig. 7 shows a shorter presence of strong interference at FHSS, which can be explained by a fast sweeping and a shorter presence of the CW interference in the narrower FHSS receive filter.

We can conclude from traces which look similar as the ones of Figs. 7 and 8, that the peak magnitude of the interference for FHSS, after a correction by a factor of 10, is mostly much larger than the peak magnitude for DSSS. The in-band interference for FHSS is often of a much shorter duration. However, for typical LAN communication with packet transmission times of up to 6 or 12 msec, the duration of destructive interference is less relevant. A retransmission is required in case of one or more erroneous bits, the number of erroneous bits in the corrupted frame is not important. Therefore, the shorter duration of the interference at FHSS does not help for the most part, while the larger magnitude of the interference causes errors to occur at smaller distances from a commercial microwave oven.

VIII. CONCLUSION

Commercial microwave ovens which have two magnetron tubes, have been evaluated with regard to their interference impact. These potential interference sources for communication in the 2.4 GHz ISM band can be

⁴ A 5th order low-pass Chebychev filter with 3 dB @ 8.8 MHz and 40 dB at 17.6 MHz.

⁵ 802.11 DSSS @ 1 Mbit/s and 2 Mbit/s allows SIRs of respectively -4 dB and -1 dB; 802.11 FHSS @ 1 Mbit/s and 2 Mbit/s allows SIRs of respectively 13 dB and 16 dB; meaning both differences are 17 dB.

expected in high population densities. This type of interference in such environments is more likely than the one from residential microwave ovens, given the number of installed ovens and the time and hours these are active. Wireless LANs operating conformant to IEEE 802.11 with either DSSS or FHSS can be subjected to the CW-like interference in the 2.4 GHz band. The higher sensitivity of FHSS to in-band CW interference shows that DSSS can persist interference from a closer commercial oven, before retransmissions will occur.

Residential ovens, luckily for wireless LANs, represent interference sources that occupy only a small part of the 2.4 GHz band, and are not active during most of the 20 msec power cycle. This allows DSSS to avoid the usage of channels which do not fall inside the disturbed frequency zone around 2.45 GHz. At channels close to 2.45 GHz, the error recovery scheme takes advantage of the silent part of the 20 msec intervals. With FHSS, most hop channels are sufficiently separated from the disturbed zone. During the periods the disturbed hop channels must be used, the error recovery scheme also takes advantage of the silent part of the 20 msec intervals.

The nature of the CW-like interference from commercial ovens is different from the nature of the residential ones. Commercial ovens give a sweeping interference tone behaviour, the sweeping is fast and over a large frequency range. A DSSS device can be about three times closer to a commercial oven than a FHSS device before frame errors occur. The shorter duration of in-band interference for FHSS than for DSSS, which uses a wider band, barely helps FHSS with regard to the frame error rate probability at typical packet transmission times (a number of msec).

And finally, regarding the claim of FHSS that they "hop around interferers", we have observed here quite an opposite behaviour. On the contrary, it is the commercial microwave oven that sweeps over multiple hop channels during a typical FHSS hop duration.

REFERENCES

- [1] Gawthrop, F. H. Sanders, K. B. Nebbia, J. J. Sell, "Radio spectrum measurements of individual microwave ovens," NTIA Report 94-303-1.
- [2] P. E. Gawthrop, F. H. Sanders, K. B. Nebbia, J. J. Sell, "Radio spectrum measurements of individual microwave ovens," NTIA Report 94-303-2.
- [3] S. Vasudevan, J. Horne, M. K. Varanasi, "Reliable wireless telephony using 2.4 GHz ISM band: Issues and solutions," in *Proc. IEEE Fourth International Symposium on Spread Spectrum Techniques & Applications*, Sept. 1996, (ISSSTA'96), Mainz (Germany), pp. 790-794.
- [4] IEEE P802.11, Draft Standard for Wireless LAN Medium Access Control (MAC) and Physical Layer Specification, P802.11 D5.1a, Jan. 1997.
- [5] A. Kamerman, "Spread spectrum schemes for microwave-frequency WLANs," *Microwave Journal*, vol. 40, no. 2, Feb. 1997, pp. 80-90.

- [6] R. Mathes, "Radiation emission from microwave ovens," *Journal of Radiological Protection*, vol. 12, no. 3, pp. 167-172, 1992.

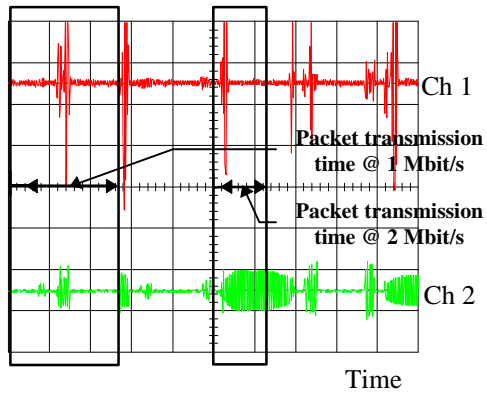

FHSS: Ch 1 5 mV/div
 DSSS: Ch 2 50 mV/div
 Time 5 ms/div

a.

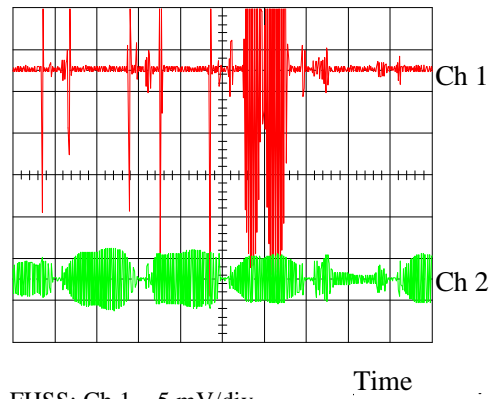

FHSS: Ch 1 5 mV/div
 DSSS: Ch 2 50 mV/div
 Time 5 ms/div

b.

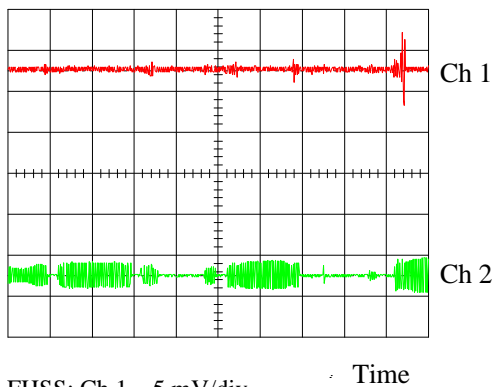

FHSS: Ch 1 5 mV/div
 DSSS: Ch 2 50 mV/div
 Time 5 ms/div

c.

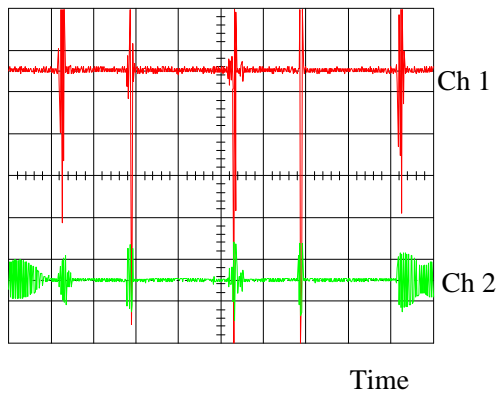

FHSS: Ch 1 5 mV/div
 DSSS: Ch 2 50 mV/div
 Time 5 msec/div

d.

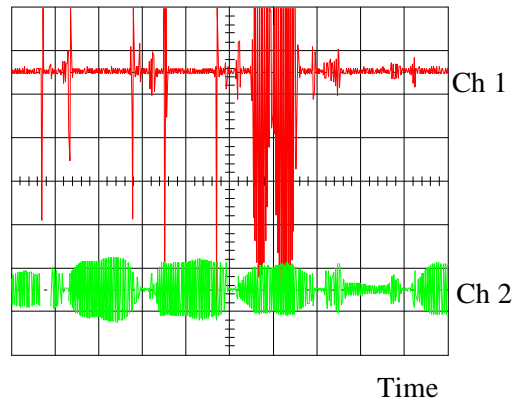

FHSS: Ch 1 5 mV/div
 DSSS: Ch 2 50 mV/div
 Time 5 ms/div

e.

Fig. 7. Interference impact for wireless LANs from model A commercial microwave oven. Upper trace represents IEEE 802.11 FHSS, lower trace represents IEEE 802.11 DSSS. Because FHSS is about 20 dB more sensitive for in-band CW interference (at lower risk of true in-band CW), the channel input of the oscilloscope is made 10 times more sensitive for fair comparison.

- a. moderate case at 2450 MHz, b. high interference case at 2450 MHz,
- c. low interference case at 2450 MHz
- d. high interference case (for FHSS) at 2420 MHz, e. high interference case (for FHSS) at 2480 MHz

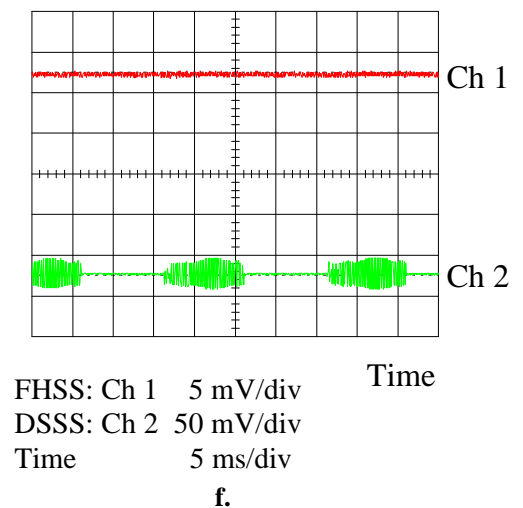
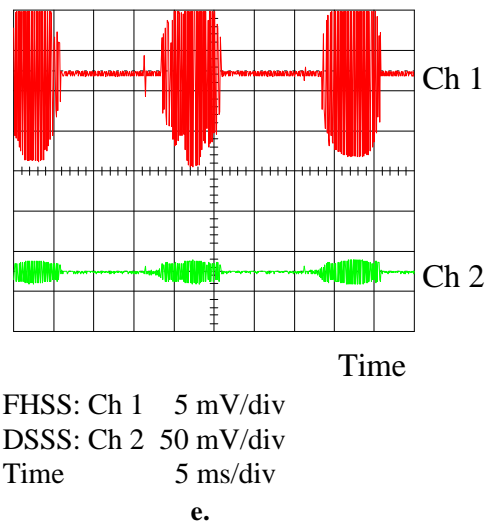
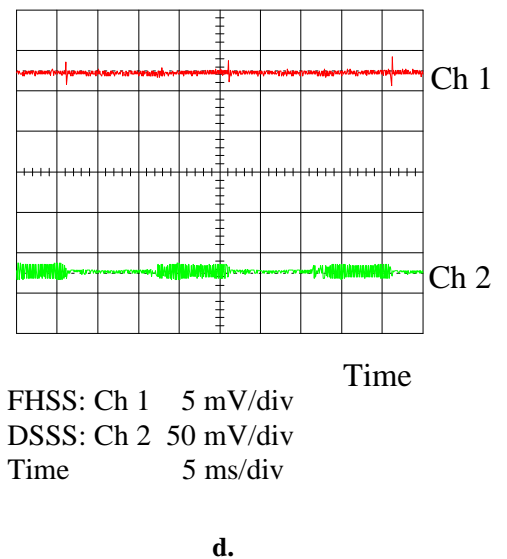
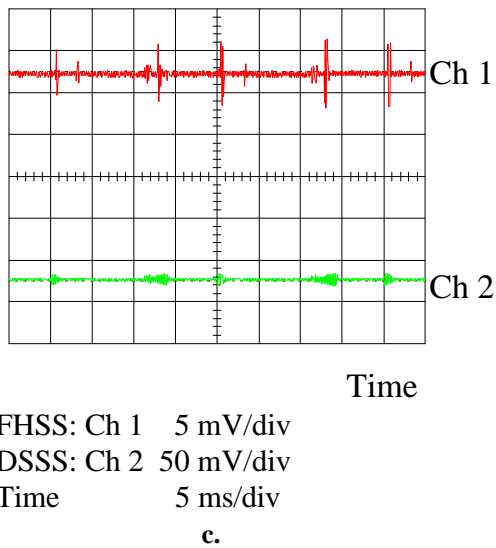
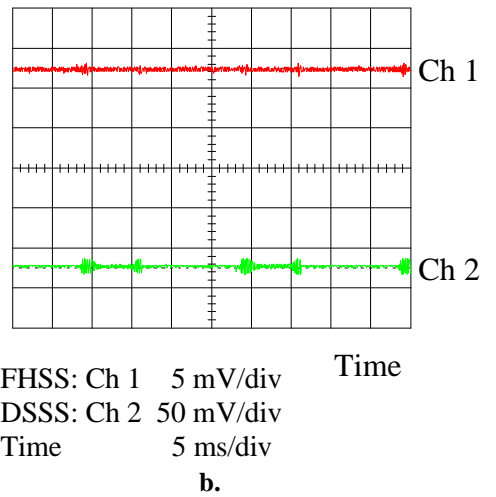
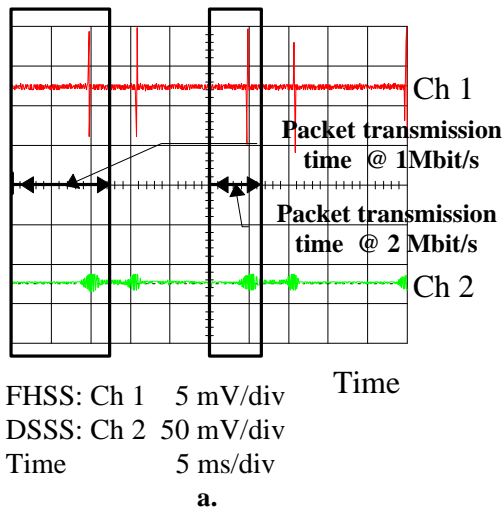

Fig. 8. Interference impact for wireless LANs from model B commercial microwave oven
Upper trace represents IEEE 802.11 FHSS, lower trace represents IEEE 802.11 DSSS. Because FHSS is about 20 dB more sensitive for in-band CW interference (at lower risk of true in-band CW), the channel input of the oscilloscope is made 10 times more sensitive for fair comparison.

- a. high interference case for FHSS at 2450 MHz, b. low interference case for FHSS at 2450 MHz,
- c. high interference case for FHSS at 2420 MHz, d. high interference case for DSSS at 2420 MHz,
- e. high interference case for FHSS at 2480 MHz, f. high interference case for DSSS at 2480 MHz.

